



GLMC Series Licalloy™

Power Inductor

Technical Data Sheet

Specification

Liquialloy™ Power Inductor GLMC Series

Features

- 7.4X6.5mm square and 3.0mm height
- Liquialloy ; Low core loss material for highly efficient power supplies
- Excellent low heat generating characteristics due to low DCR (Direct Current Resistance)
- Metal composite structure provides compact and support high current
- Operating Temperature : -20 ~ +125°C (Including self temperature rise)
- RoHS compliant

Application

- For use in DC/DC converters in notebook PCs and servers, etc.
- POL (Point of Load) power supplies



Outer Appearance of Liquialloy™ Inductor

ALPS Part No.	Inductance (μ H) at 100kHz	DC Resistance* (m Ω)	Rated Current	
			Saturation Current $\Delta L/L=30\%$ (A) Max. (Typ.)	Heat Rating Current $\Delta T=40^{\circ}\text{C}$ (A) Max. (Typ.)
GLMCR4703A	0.47 \pm 20%	3.1 \pm 10%	13.9 (16.2)	15.4 (16.8)
GLMC1R003A	1.0 \pm 20%	5.8 \pm 10%	10.0 (11.7)	10.6 (11.5)
GLMC1R503A	1.5 \pm 20%	9.1 \pm 10%	8.4 (9.8)	8.8 (9.5)
GLMC2R203A	2.2 \pm 20%	12.4 \pm 10%	7.1 (8.3)	7.5 (8.2)
GLMC3R303A	3.3 \pm 20%	20.0 \pm 10%	6.0 (7.0)	6.2 (6.6)
GLMC4R703A	4.7 \pm 20%	26.9 \pm 10%	5.1 (6.0)	5.1 (5.6)

* : measured under 20°C.



Specification

Liquialloy™ Power Inductor GLMC Series

Outline Dimensions and Schematics

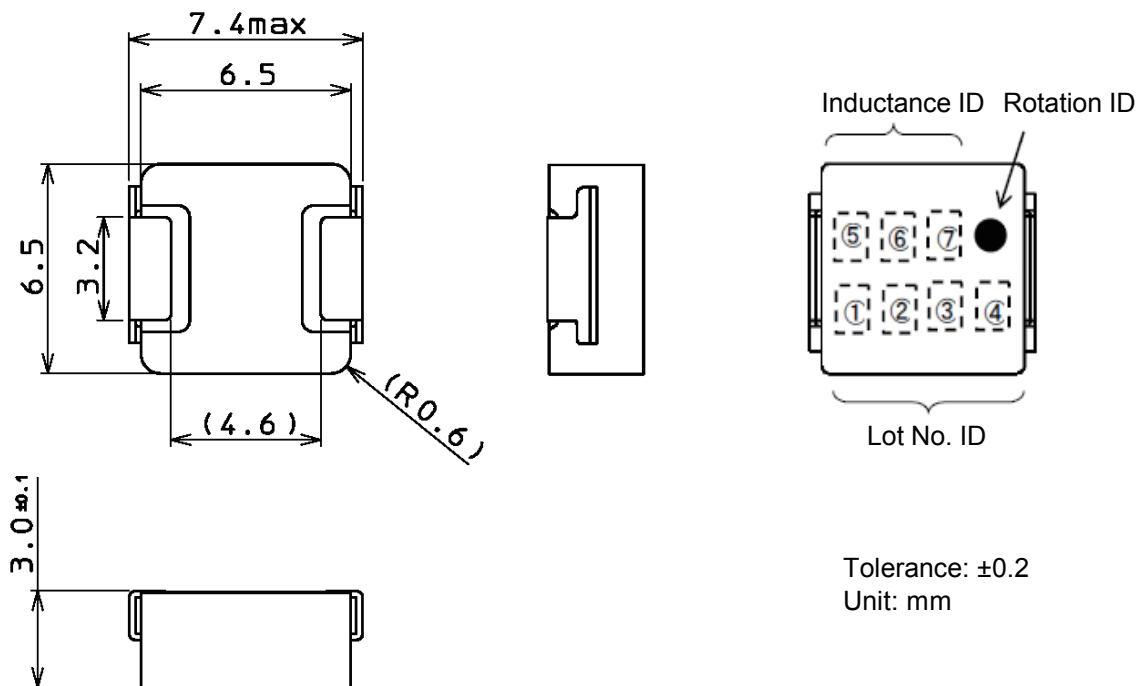

Recommend Land Pattern Dimensions

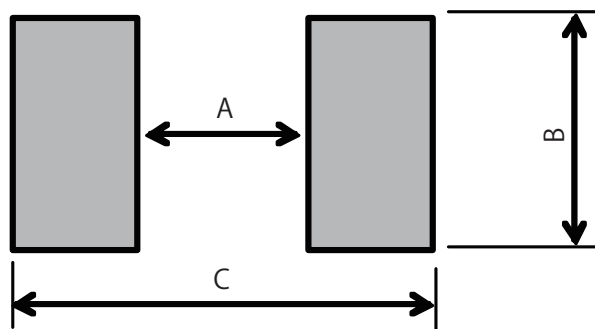

A	4
B	3.5
C	8

Unit: mm



DC bias characteristics

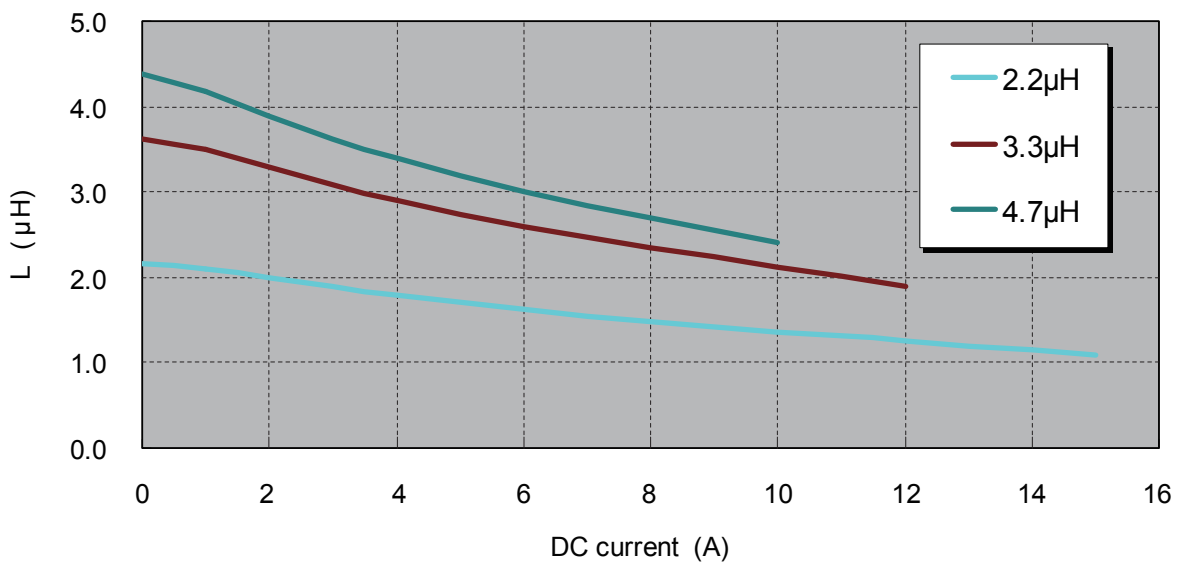
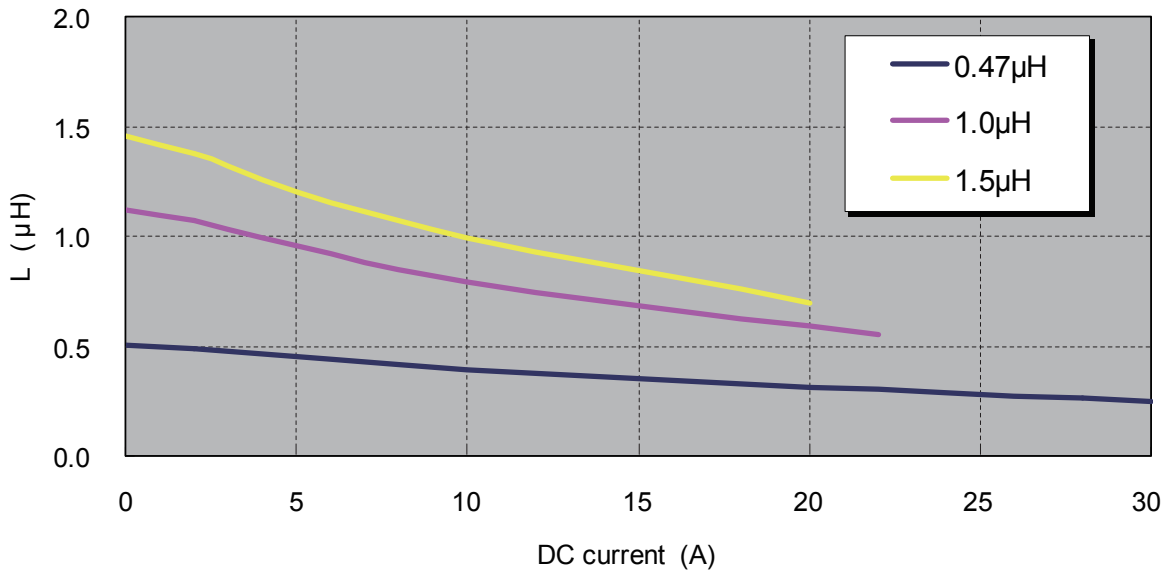

Q-f characteristics

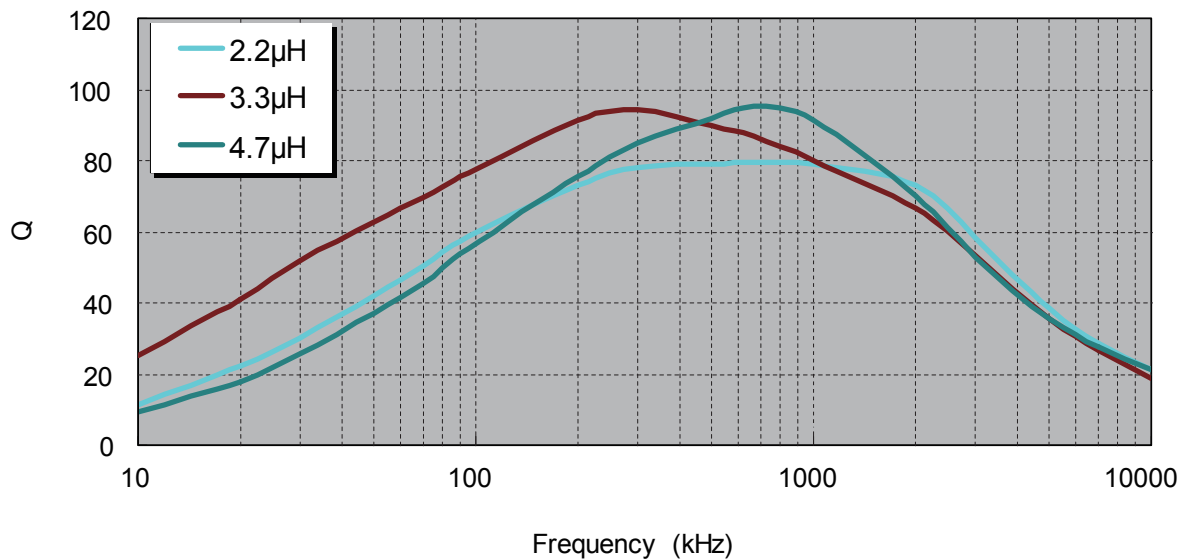
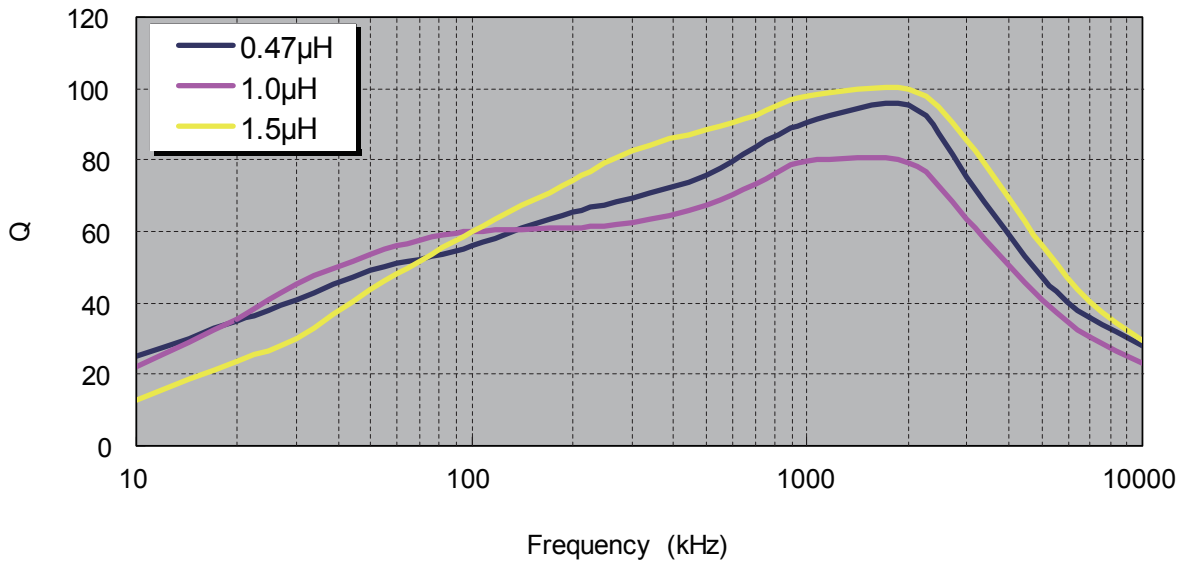

Temperature rise (ΔT) dependence of the Liquialloy™ Power Inductors on Load Current

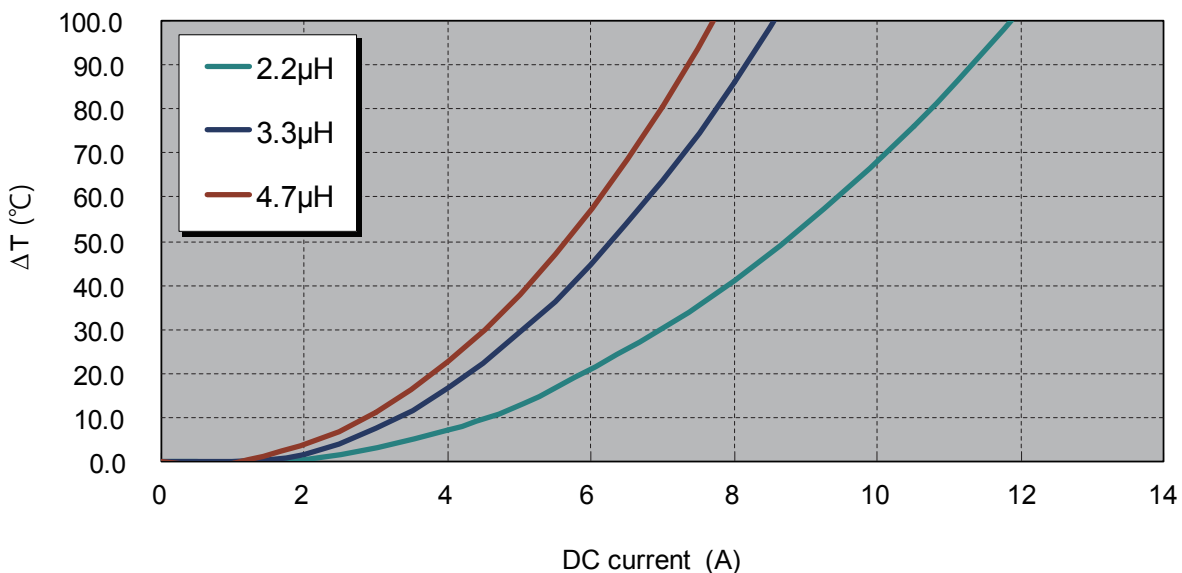
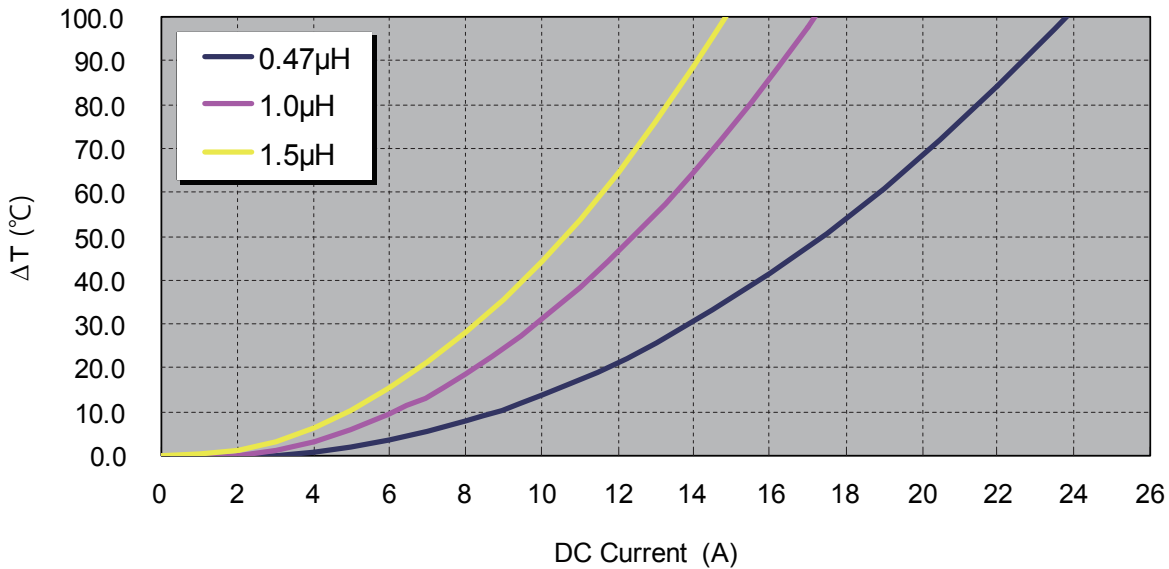

Packing

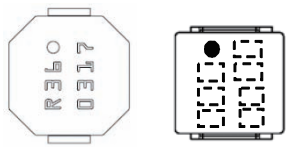
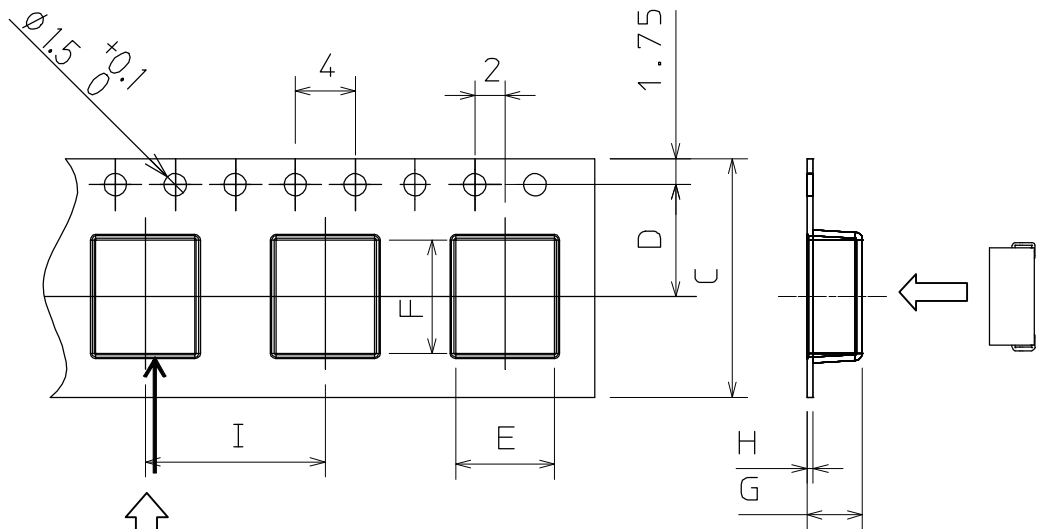
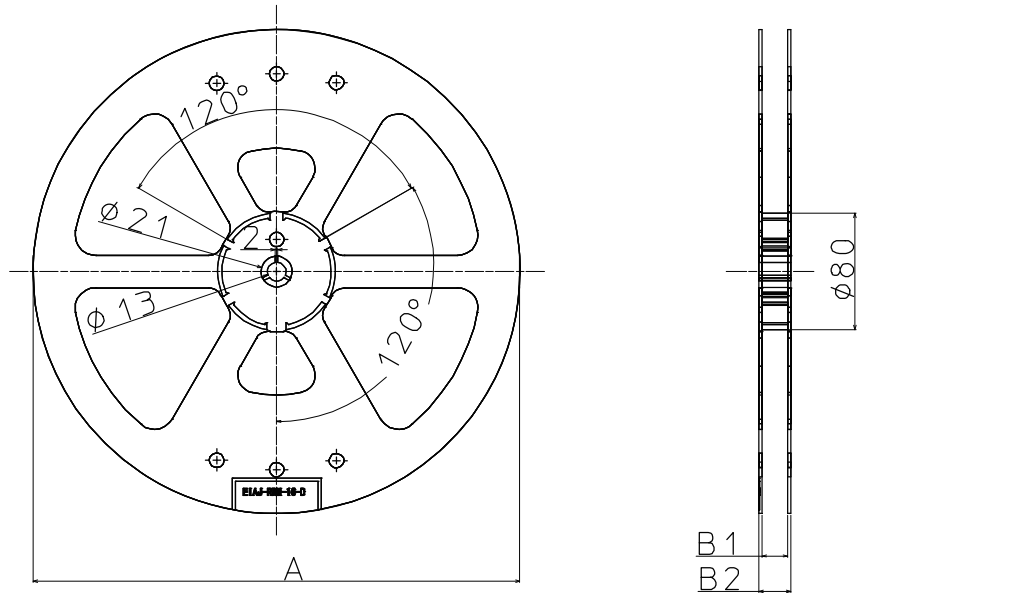

Unreeing direction

Unit: mm

	Reel Size			Tape Size						QNT	
	A	B1	B2	C	D	E	F	G	H		I
GLMC/GLMH	φ330	17.5	21.5	16	7.5	6.8	7.8	3.3	0.4	12	1000
GLMD	φ330	25.4	29.4	24	11.5	10.5	12.1	4.3	0.4	16	1000



Attention

Precautions when handling our products

1. For the export of products which are controlled items subject to foreign and domestic export laws and regulations, you must obtain approval and/or follow the formalities of such laws and regulations.
2. Products must not be used for military and/or antisocial purposes such as terrorism, and shall not be supplied to any party intending to use the products for such purposes.
3. Unless provided for otherwise, the products have been designed and manufactured for application in equipment and devices which are sold to end users in the market, including audio-visual (AV) equipment, electrical home appliances, office machines, information and communication equipment, and amusement equipment. The products are not intended for use in, and must not be used for, any application for nuclear equipment, driving equipment for aerospace or any other unauthorized use. With the exception of the abovementioned prohibited applications, please contact an Alps sales representative and/or evaluate the total system regarding applicability for applications involving high levels of safety and liability such as medical equipment, burglar alarm equipment, disaster prevention equipment and undersea equipment. Please also incorporate fail-safe design, protection and redundant circuitry, malfunction protection, and/or fire protection into the complete system to ensure safety and reliability of the total system.
4. Before using products which were not specifically designed for use in automotive applications, please contact an Alps sales representative.

Cautions regarding this technical data sheet

1. The specifications herein are an overview of the specifications. Obtain official specifications before use.
2. The colors of the products this technical data sheet may slightly differ from those of the actual products.
3. The external appearance, functions and other specifications herein may be discontinued without prior notice.

■ Inquiries about Products

Products Information Center

+81 (3) 5499-8154

Products Information Site

[Http://www.alps.com/products/e/](http://www.alps.com/products/e/)

Development, Production

ALPS GREEN DEVICES CO., LTD.

Sales

ALPS ELECTRIC CO., LTD.

1-7, Yukigaya-otsukamachi, Ota-ku, Tokyo, Japan 145-8501

